

## 6. DIP Switches Settings

Total 6 bits in the DIP switches can be configured. The switches can be modified either before or after installation.

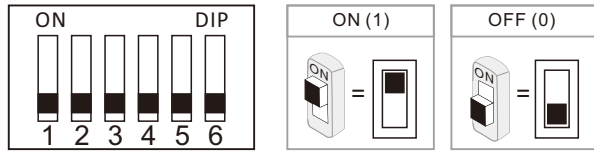

**Bit-1, Bit-2 and Bit-3 are used for door station ID setting (1=on, 0=off).**

000 - 100 - 010 - 110 - 001 - 101 - 011 - 111

000 - First door station

100 - Second door station

010 - Third door station

110 - Fourth door station

If there's extra camera connected with the system. The door station ID would be

000 - First door station

010 - Second door station

001 - Third door station

011 - Fourth door station

**Bit-4 and Bit-5 is used for unlock time setting.**

00 - 1 second (Default setting)

10 - 5 seconds

01 - 10 seconds

11 - 15 seconds

**Bit-6 is used for connecting extra camera.**

0 - No extra camera (Default setting)

1 - Connecting with extra camera

## 7. Electric Lock Connection

1. The door lock power for a 12v DC strike (max current=250mA).
2. Set the jumper SIP1 set to 1-2 for a normally closed lock (power OFF to open), or set SIP1 to 2-3 for a normally open lock (power ON to open).

3. Adjust the timer setting with Bit-4 and Bit-5 at the outdoor station (1=on, 0=off)

00-1sec, 01-5sec, 10-10sec, 11-15sec

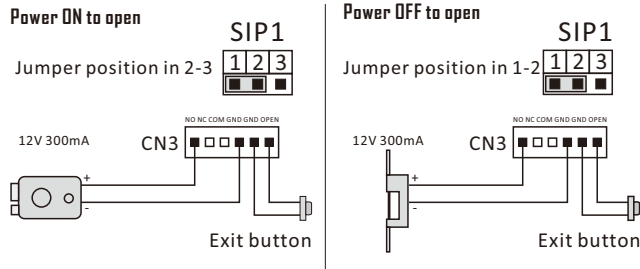

## 8. Electric Lock Connection

1. The external power supply must be used according to the lock.
2. The jumper must be taken off before connecting.
3. If different unlocking time is needed, change the unlock time on door station by modifying the BIT-4 and BIT-5.

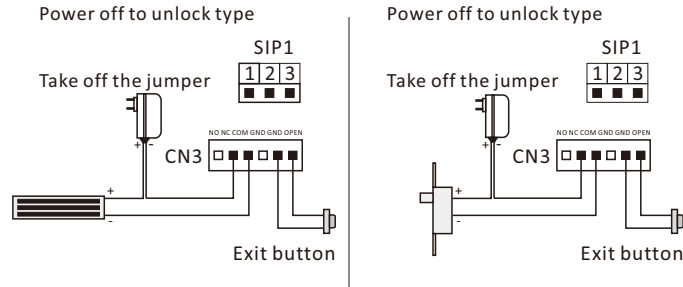

## 9. Specification

- Power supply: DC 24V
- Power Consumption: 1W in standby, 5W in working
- Unlock Power output: 12Vdc, 250mA
- Unlock timing: 1s, 5s, 10s, 15s
- Working Temperature: -20°C~ +55°C

The design and specifications can be changed without notice to the user. Right to interpret and copyright of this manual are preserved.

# Door Station

## 2-wire Door Station

### Quick Installation Guide

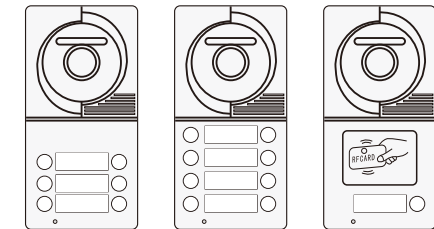
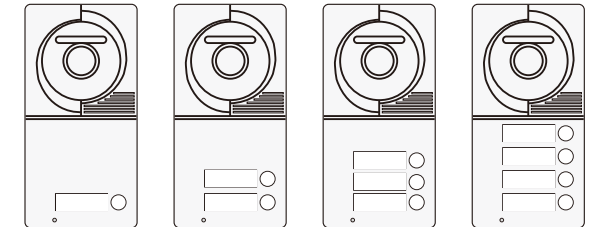

Please read this manual carefully before using the product.

# 1. Parts and Functions

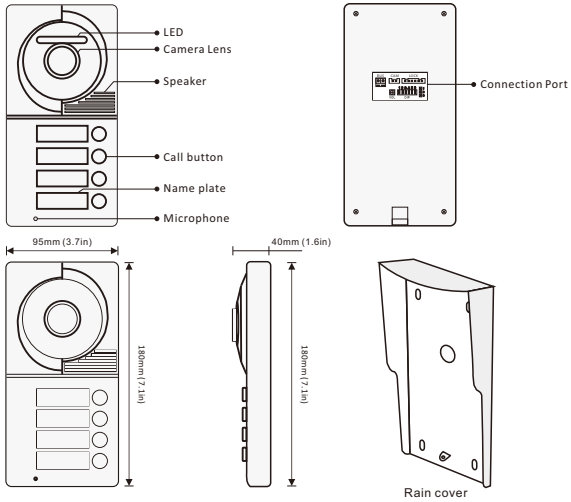

# 2. Terminal Description

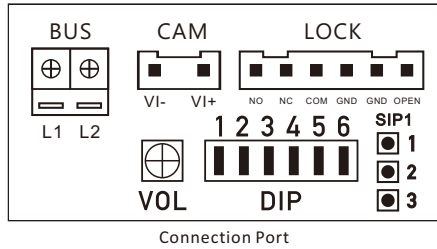

- **BUS:** (L1, L2) non-polarity bus line
- **CAM:** Extra camera connection port
- **LOCK:** Electronic lock connection port
- **VOL:** Volume adjustor
- **DIP:** DIP switches for system configurations.

# 3. Place Name Label

Press down and move left to open the transparent nameplate cover. Then insert the name paper and put the cover back.

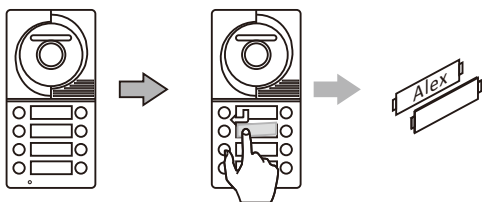

# 4. Mounting

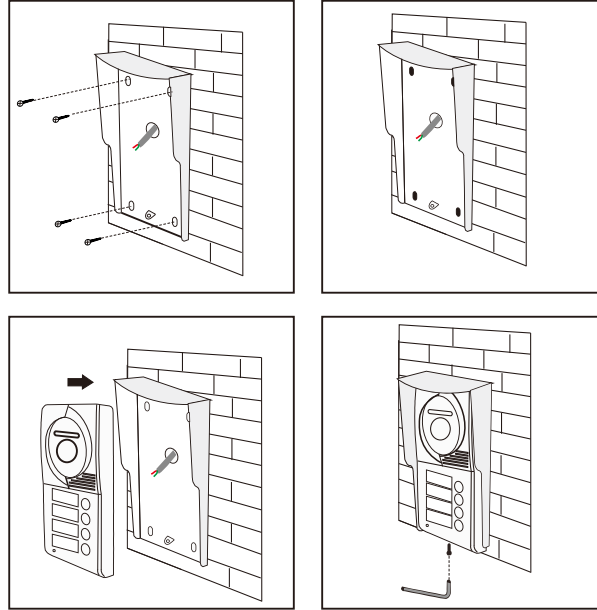

# 5. System Connection

## Multi door station

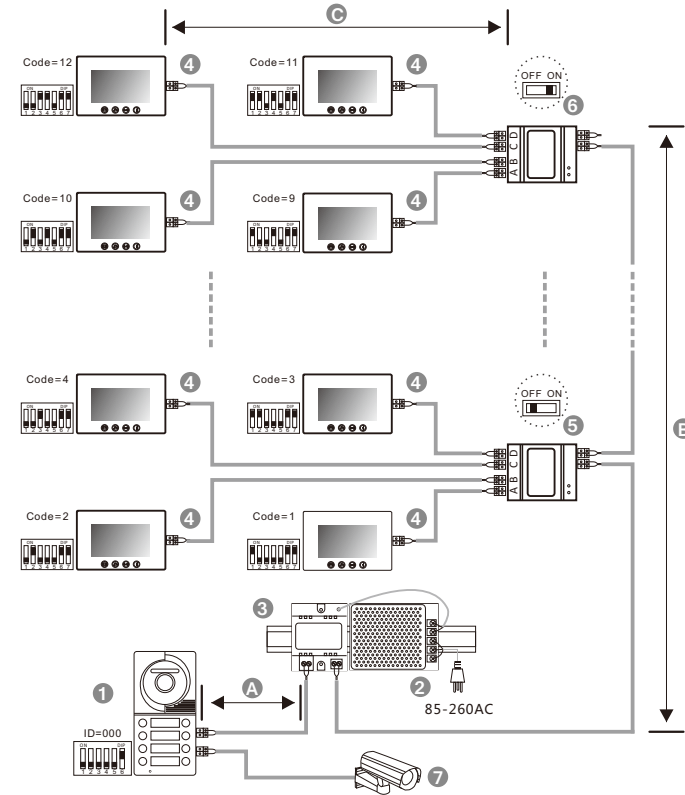
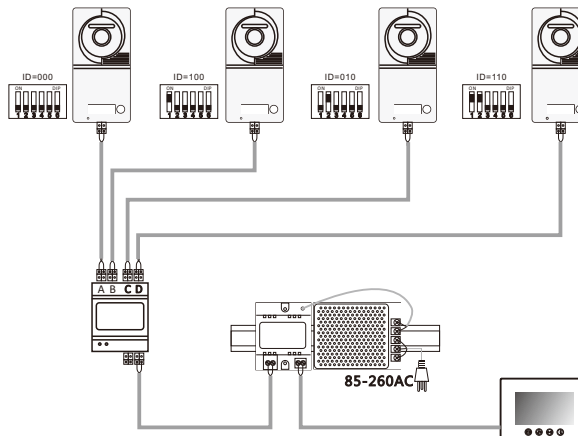

### When monitor quantity < 20

Cable Usage	A	B	C
Parallel cable 2x0.75mm <sup>2</sup>	60	60	30
Parallel cable 2x1mm <sup>2</sup>	80	80	40

### When monitor quantity > 20

Cable Usage	A	B	C
Parallel cable 2x1mm <sup>2</sup>	60	60	30
Parallel cable 2x1.5mm <sup>2</sup>	80	80	40

[1]: Door station, when there is only one Door station, the DIP bit-1, bit-2 and bit-3 should be set to 000.

[2]: Power supply, MUST be installed side by side with Power Separator.

[3]: Power Separator, MUST be installed side by side with Power supply.

[4]: Monitor, each one with an unique User Code, note that all the bit-6 of the DIP should be set to 1(ON) in this case.

[5]: Video distributor set switch to OFF unless at the end of the line.

[6]: Video distributor set switch to ON at the end of the line.

[7]: Extra camera.

## 6. DIP Switches Settings

Total 6 bits in the DIP switches can be configured. The switches can be modified either before or after installation.

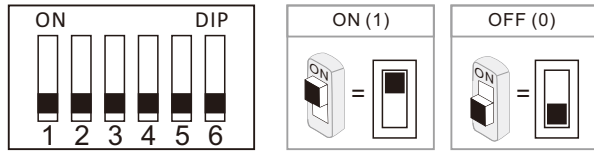

**Bit-1, Bit-2 and Bit-3 are used for door station ID setting (1=on, 0=off).**

000 - 100 - 010 - 110 - 001 - 101 - 011 - 111

000 - First door station

100 - Second door station

010 - Third door station

110 - Fourth door station

If there's extra camera connected with the system. The door station ID would be

000 - First door station

010 - Second door station

001 - Third door station

011 - Fourth door station

**Bit-4 and Bit-5 is used for unlock time setting.**

00 - 1 second (Default setting)

10 - 5 seconds

01 - 10 seconds

11 - 15 seconds

**Bit-6 is used for connecting extra camera.**

0 - No extra camera (Default setting)

1 - Connecting with extra camera

## 7. Electric Lock Connection

1. The door lock power for a 12v DC strike (max current=250mA).

2. Set the jumper SIP1 set to 1-2 for a normally closed lock (power OFF to open), or set SIP1 to 2-3 for a normally open lock (power ON to open).

3. Adjust the timer setting with Bit-4 and Bit-5 at the outdoor station

(1=on, 0=off)

00-1sec, 01-5sec, 10-10sec, 11-15sec

Power ON to open

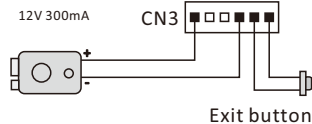
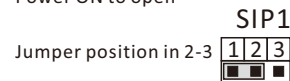

Power on to unlock type

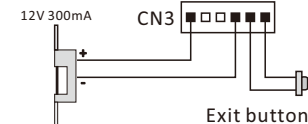
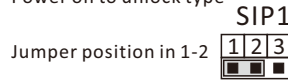

## 8. Electric Lock Connection

1. The external power supply must be used according to the lock.

2. The jumper must be taken off before connecting.

3. If different unlocking time is needed, change the unlock time on door station by modifying the BIT-4 and BIT-5.

Power off to unlock type

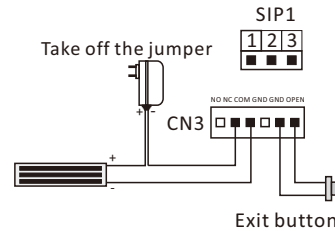

Power off to unlock type

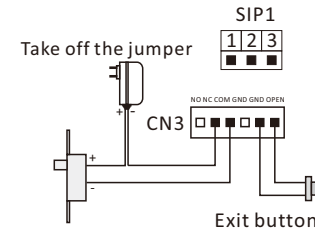

## 9. Specification

- Power supply: DC 24V
- Power Consumption: 1W in standby, 5W in working
- Unlock Power output: 12Vdc, 250mA
- Unlock timing: 1s, 5s, 10s, 15s
- Working Temperature: -20°C~ +55°C

## 10. User Instructions of RFID Access Control

1) **Make a master card:**

Firstly to cut off the power of the outdoor station, secondly to connect JP2 with power, then sound will be heard every 1.5second, now to swipe new ID card will hear a long beep, that means new master card has been made, finally to take off JP2 will exit.

2) **Delete all user cards:**

Firstly to cut off the power of the outdoor station, then to connect JP3 with power, now a long beep will be heard, that means all user cards has been deleted, finally to take off JP3 will exit.

3) **Add more user ID card:**

Under standby, firstly to swipe the Master card, then to swipe new User cards one by one, now to swipe the Master card again, so new User cards have been made. only 2720pcs user cards can be made in the system.

4) **Open the door by ID user card:**

Under standby, to swipe the active access ID user card on the access window will open the door, if the User card is not activated by the Master card, then the door can not be open and Dee beep will be heard at 3 times.

# Door Station

## 2-wire Door Station

### Quick Installation Guide



Dimension: 195(H)×130(W)×52(D)mm

Embedded Dimension: 185(H)×110(W)×33(D)mm

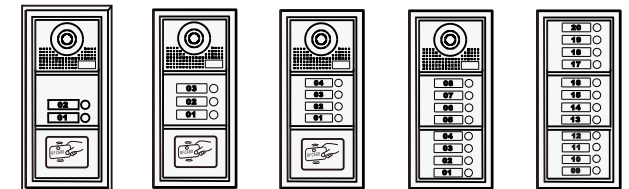

Dimension: 276(H)×130(W)×52(D)mm

Embedded Dimension: 270(H)×108(W)×33(D)mm

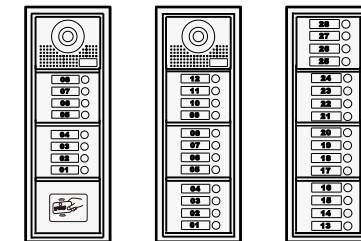

Dimension: 360(H)×130(W)×52(D)mm

Embedded Dimension: 350(H)×110(W)×33(D)mm

## 1. Parts and Functions

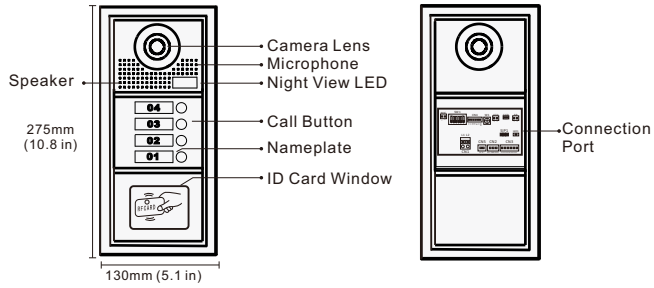

## 2. Terminal Description

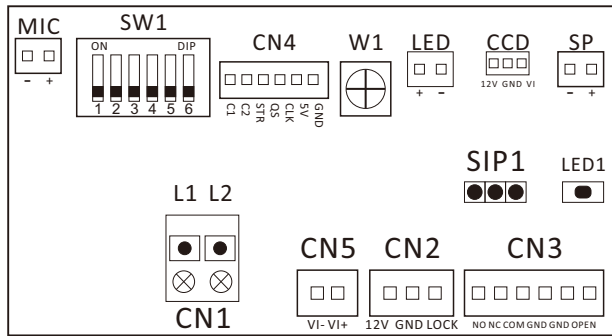

- **MIC:** Microphone connection part
- **SW1:** DIP switches for system configurations.
- **CN4:** Call button module connection port
- **W1:** Volume adjustor
- **LED:** Night vision light connection port
- **CCD:** Camera module connection port
- **SP:** Speaker connection part
- **CN1:** (L1, L2) non-polarity bus line
- **CN5:** Extra camera connection port
- **CN2:** Card reader module connection part

## 3. Place Name Label

Press down and move left to open the transparent nameplate cover. Then insert the name paper and put the cover back.

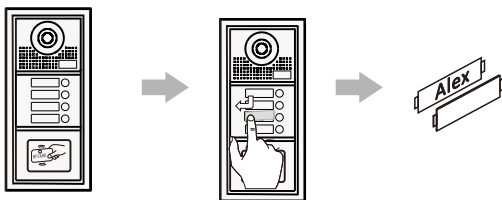

## 4. Mounting

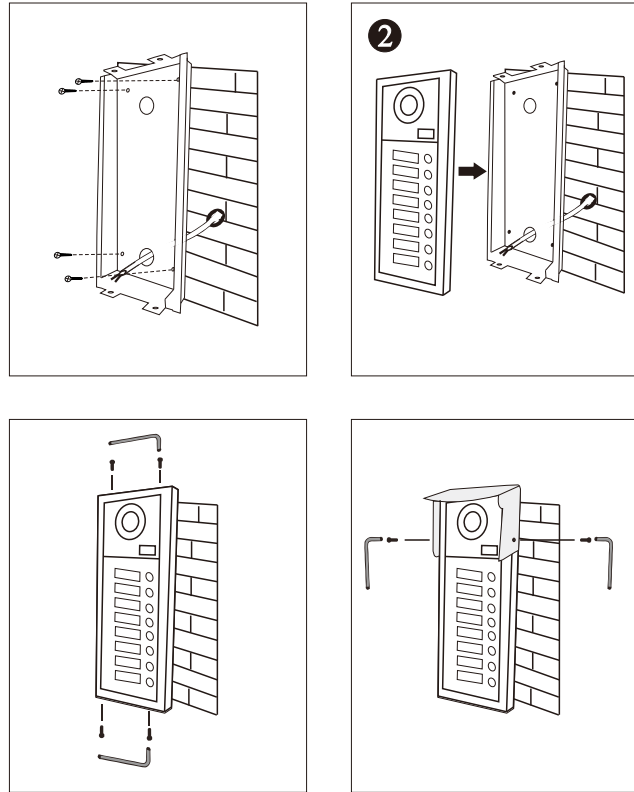

## Installation with expanding panel

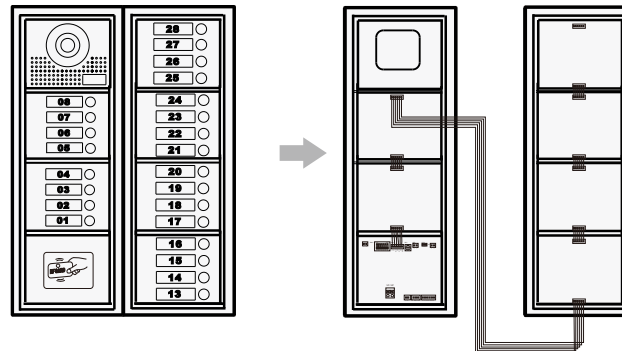

## 5. System Connection

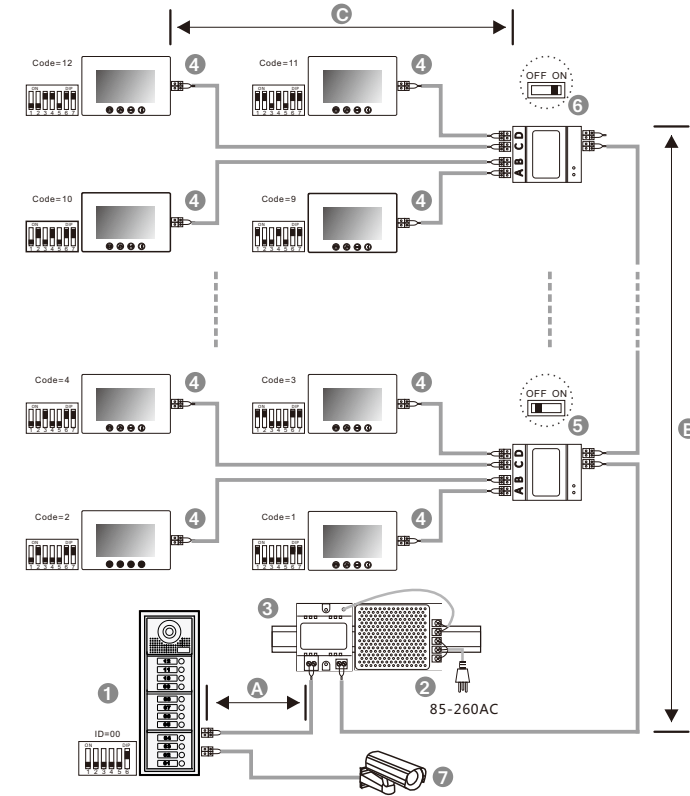

When monitor quantity < 20

Cable Usage	A	B	C
Parallel cable 2x0.75mm <sup>2</sup>	60	60	30
Parallel cable 2x1mm <sup>2</sup>	80	80	40

When monitor quantity > 20

Cable Usage	A	B	C
Parallel cable 2x1mm <sup>2</sup>	60	60	30
Parallel cable 2x1.5mm <sup>2</sup>	80	80	40

[1]: Door station, when there is only one Door station, the DIP bit-1 bit-2 and bit-3 should be set to 000.

[2]: Power supply, MUST be installed side by side with Power Separator.

[3]: Power Separator, MUST be installed side by side with Power supply.

[4]: Monitor, each one with an unique User Code, note that all the bit-6 of the DIP should be set to 1 (ON) in this case.

[5]: Video distributor set switch to OFF unless at the end of the line.

[6]: Video distributor set switch to ON at the end of the line.

[7]: Extra camera.



## 4. Picture memory (Optional Function)

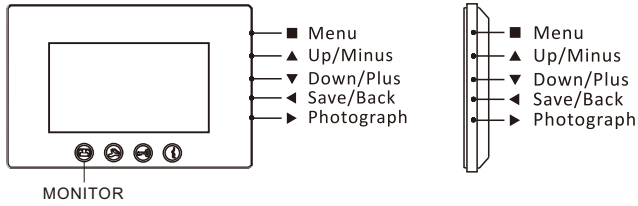

### [1] Time setting

Press MONITOR button, press **■** to choose the Date, then pressing **▲** to adjust the Year. By pressing **■** again to the next. Next is the Month and the Day. Then press **◀** to complete.

### [2] Review picture

Press MONITOR button, then press **▲** to review pictures.

### [3] Delete picture

Press MONITOR button, press **▲** to review picture, press **■** to choose a picture, press **■** again to delete this picture.

### [4] Delete all pictures

Press MONITOR Button, press **■** to choose DELETE ALL, confirm by pressing **▲** again.

### [5] Manually photograph

Press MONITOR Button, press **▶** to save a picture. Max NO. of saved picture is-240.

## 5. User Codes (Monitor bit codes) Setup

- Every room station must have an ID, set through the bit codes(list right)
- Bit-1 to Bit-5 are used to configure the room ID.
- Bit-6 is the line-terminal switch, set the LAST monitor to ON, otherwise set OFF.
- Bit-7 is to turn the ringtone at the door station ON/OFF.
- You can have a Max of 4 monitor per button/code.



Monitor **NOT** at the end of the line

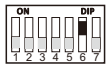

Monitor at the end of the line

Bit-6 line terminal setting

Bit state	User Code	Bit state	User Code	Bit state	User Code
	Code=1		Code=12		Code=23
	Code=2		Code=13		Code=24
	Code=3		Code=14		Code=25
	Code=4		Code=15		Code=26
	Code=5		Code=16		Code=27
	Code=6		Code=17		Code=28
	Code=7		Code=18		Code=29
	Code=8		Code=19		Code=30
	Code=9		Code=20		Code=31
	Code=10		Code=21		Code=32
	Code=11		Code=22		

- Power supply: DC 24V (supplied by adaptor)
- Power consumption: Standby 15mA, working 350mA
- Picture memory: 240pcs
- Wiring: 2 wires, non-polarity
- Monitor time: 90 seconds
- Talking time: 90 seconds

\*Revision: PL161226

# VIDEO DOOR PHONE

## USER MANUAL

Please read this manual carefully before using the product.

# 1. Parts and Functions

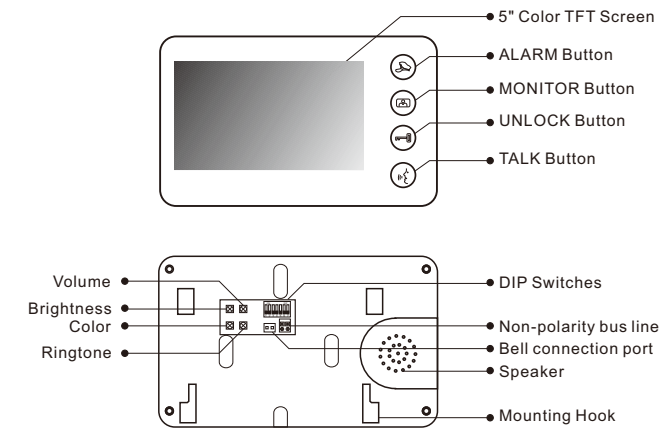
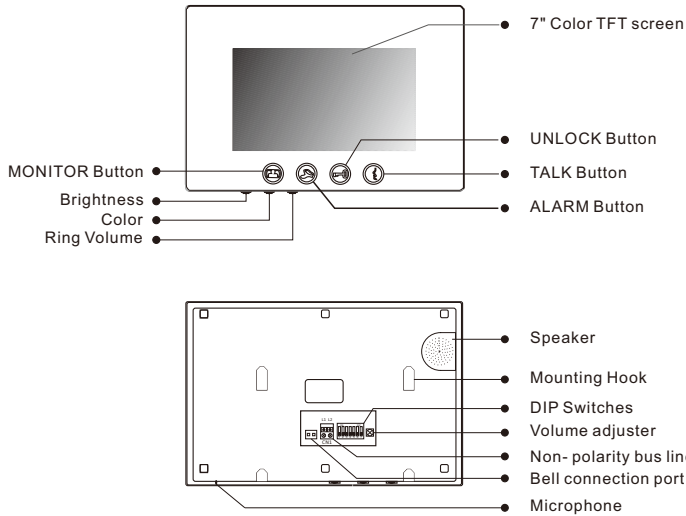

## 2. Monitor Mounting

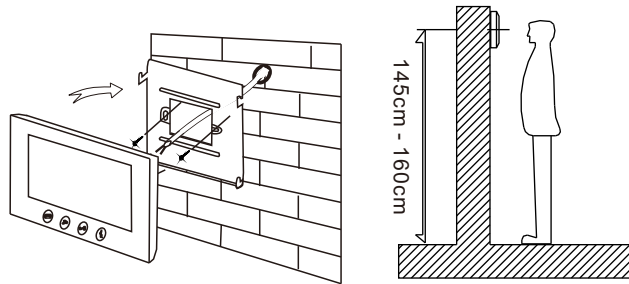

- Using the screws to fix the Mounting Bracket on the wall.
- Connecting the system correctly, then hang the Monitor on the mounting bracket firmly.

## 3. Operation Instructions

### • Answering a door call

Press CALL button on door station, the monitor rings, the visitor can be seen on the monitor screen. If nobody answers the call, the screen will automatically turn off in 30 seconds.

To answer an incoming call, press TALK to answer, calls last for 90 seconds-you DO NOT have to hold talk to enable voice communication. Press TALK again to end the conversation. If the system connects with two or more monitors, answering any monitor, the others will turn off automatically.

If there is an extra camera, during and incoming call, press MONITOR switch to see the view of extra camera.

### • Door Release

During the conversation with the visitor, press UNLOCK button to unlock the door.

### • Monitoring

Press MONITOR button while in standby mode you will be able to see the view of outdoor station camera. Press MONITOR again switch to next door station camera or extra camera. Press TALK button twice to exit.(firstly you should have finish setting door station camera and extra camera, see below)

### • How to set door station camera and extra camera?

On door station - Connect the door station with the extra camera, set the Bit-6 to ON.

On Monitor - Keep pressing ALARM button until it beep. Press MONITOR as many times as the quantity of door station and extra camera, (for example there are 3 door stations, 2 door station with extra camera, press MONITOR 5 times), press ALARM again. Then cut off the power and restart the monitor.

Press MONITOR until it beep, the camera switching mode should be changed between manually and automatically.

### • Inner Call

User can call other apartments by pressing ALARM button. To start the Inner call, first you need to setup a dial number on the monitor.

### • How to setup the dial number on the monitor ?

Keep pressing UNLOCK button until you hear a long beep. Start setting 2 digit dial number.

MONITOR button refers to first digit 1~9

UNLOCK button refers to 0 / confirm.

Eg. Set the dial number to 09.

press UNLOCK (Long beep) - press UNLOCK - press MONITOR 9 times - press UNLOCK

Set the dial number to 10.

press UNLOCK (Long beep) - press MONITOR 1 time - press UNLOCK -press UNLOCK

Set the dial number to 12

press Unlock(Long beep) - press MONITOR 1 times - press UNLOCK - press MONITOR 2 times -press UNLOCK

### • How to change the ring tone?

Keep pressing TALK button until you hear a long beep, current ring tone will be displayed.

There are 9 ring tones to choose from, press ALARM button to choose the ring tone you want.

Press TALK button again to save and exit.

### • How to set multiple door station and extra camera?

On door station - Connect the door station with the extra camera, set the Bit-6 to ON.

On Monitor - Keep pressing ALARM button until it beep. Press MONITOR as many times as the quantity of door station and extra camera, (for example there are 3 door stations, 2 door station with extra camera, press MONITOR 5 times), press ALARM again and then cut the power off and re-start the monitor.

By pressing MONITOR button, the camera switching mode could be changed between manually and automatically.

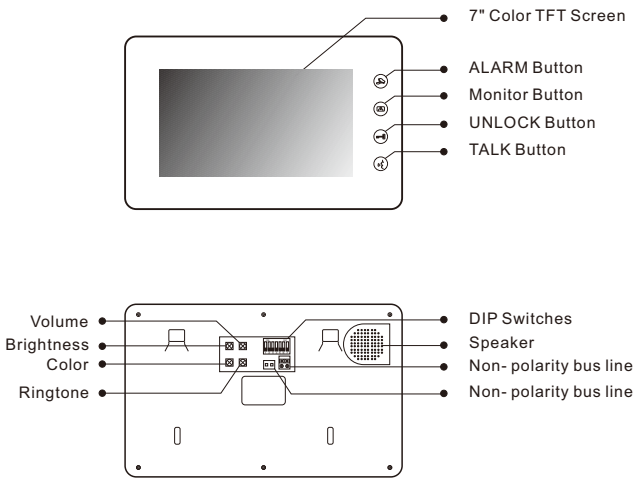

## Multi-monitors wiring

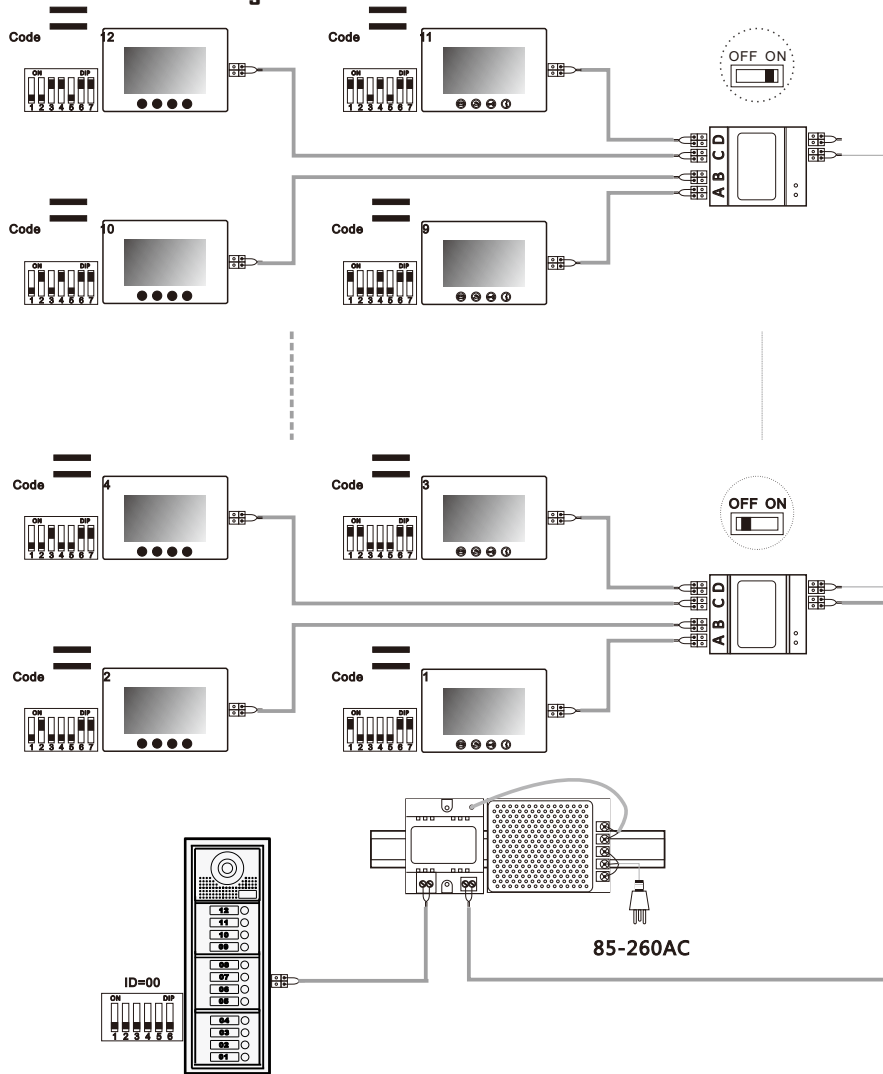

## USER MANUAL

## 2-wire Accessories Video Distributor

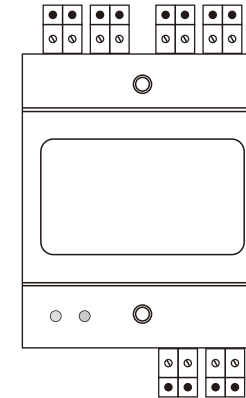

Power supply: DC20~30V  
 Working Temperature: -10 C ~ +40 C  
 Wiring: 2-wires (Non-polarity)  
 Dimension: 89(H) × 71(W) × 45(D)mm

Description: Video distributor with 4 branches with the function of isolation and protection.

- Can be used as 4 inputs (Outdoor stations) controller or 4 outputs (Indoor monitor) controller;
- Separate isolation protection without affecting another devices on the bus system;
- Short-circuit indication for convenient maintenance;
- Periodic self-detection mechanism for recovery.

## 1. Parts and Functions

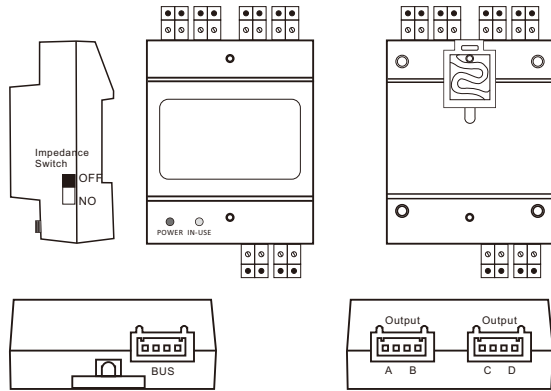

**IN-USE:** Status indicator, it will light up when receives signal.

**POWER:** Working indicator, it will light up when plugs in power supply.

**Impedance Switch:** Video match switch, the last video distributor at the end of the bus should set ON to match the video impedance, the power indicator will turn to orange after setting.

**Bus:** Input port, bus connection port.

**A, B, C, D:** Output port, connect to indoor monitors or door stations.

### Note:

- Operation mode: Protection mode will be activated once its connected devices are short circuited, and power supply for ABCD outputs will be turn off, the flashing in-use indicator shows the distributor is in the protection mode.
- Self-detection: System will auto check whether the short circuit is fixed or not, then recover the power supply, and in-user indication will be turn off;

- Detection period: Self-detection will be happened regularly according rules, and in-use indicator will flash rapidly three times when check happens;  
1st detection will be happened in 10 seconds after short circuit;  
2nd detection will be happened in 60 seconds after 1st detection;  
3rd detection will be happened in 5 minutes after 2nd detection;  
4th detection will be happened in 10 minutes after 3rd detection;  
5th hereafter detection will be happened every 30 minutes.

## 2. Unit Mounting

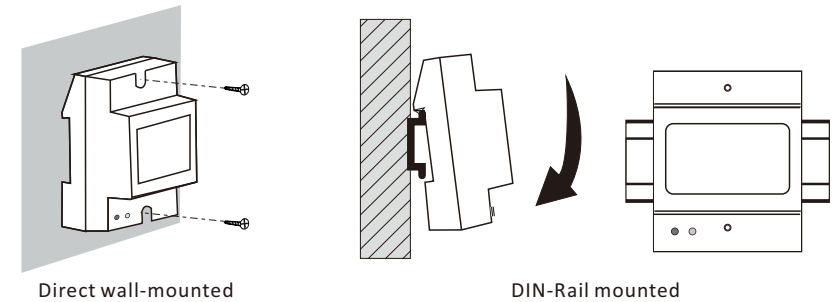

## 3. Wiring

### Multi-door station

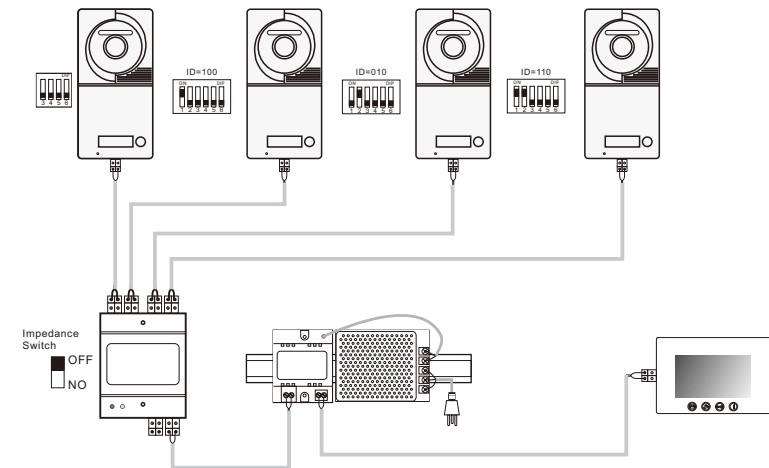

---

---

# USER MANUAL

**2-wire Accessories**  
**Power supply**

---

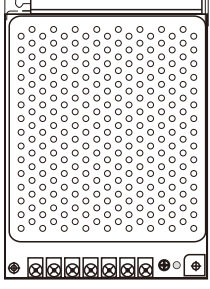

\* Revision: PL161226

Please read this manual carefully before using the product.

---

---

# USER MANUAL

**2-wire Accessories**  
**Power supply**

---

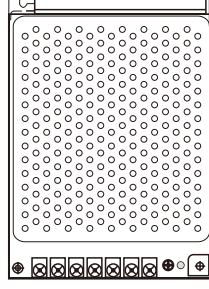

\* Revision: PL161226

Please read this manual carefully before using the product.

## 1. Description

2-wire system 24V Power supply with Din-rail mounting or metal box.

- Din-rail or metal box mounting
- 10 DIN modules
- DC24V 1.5A output

## 2. Parts and Functions

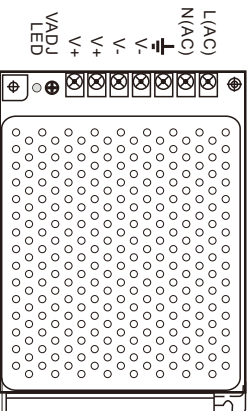

- L(AC): AC input.
- N(AC): AC input.
- : Earth Ground.
- V-: DC power output (21.5~26.5 adjustable)
- V+: DC power output (21.5~26.5 adjustable)
- VADJ: Output voltage adjustment.
- LED: Working state indication.

-1-

## 3. Installation

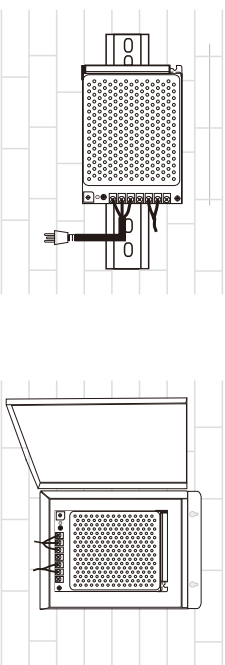

DIN rail mounting

Box mounting

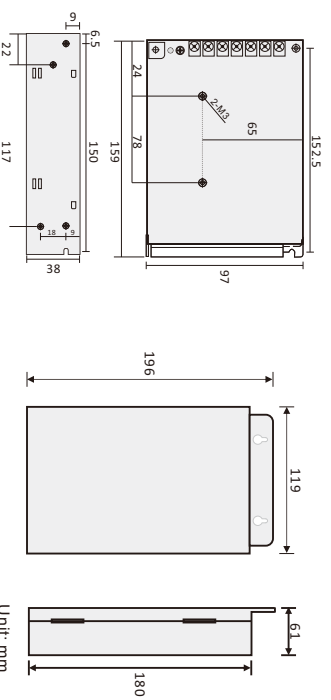

## 4. Specification

- Input Voltage:
- Input Frequency:
- Rated Output Voltage:
- Rated Output Current:
- Working Temperature:

100~120VAC(2.5A), 200~240VAC(1.5A)  
50~60 Hz  
24Vdc  
1.5A  
-20 C~+60 C

-2-

## 1. Description

2-wire system 24V Power supply with Din-rail mounting or metal box.

- Din-rail or metal box mounting
- 10 DIN modules
- DC24V 1.5A output

## 2. Parts and Functions

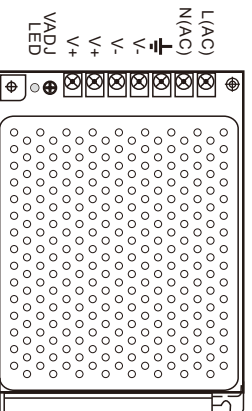

- L(AC): AC input.
- N(AC): AC input.
- : Earth Ground.
- V-: DC power output (21.5~26.5 adjustable)
- V+: DC power output (21.5~26.5 adjustable)
- VADJ: Output voltage adjustment.
- LED: Working state indication.

-1-

## 3. Installation

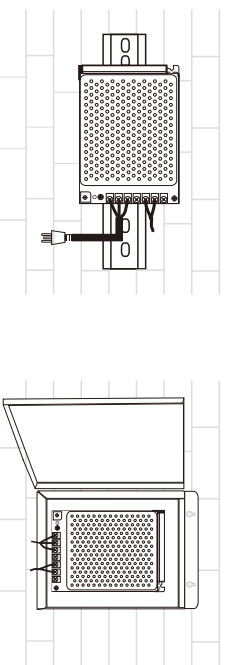

DIN rail mounting

Box mounting

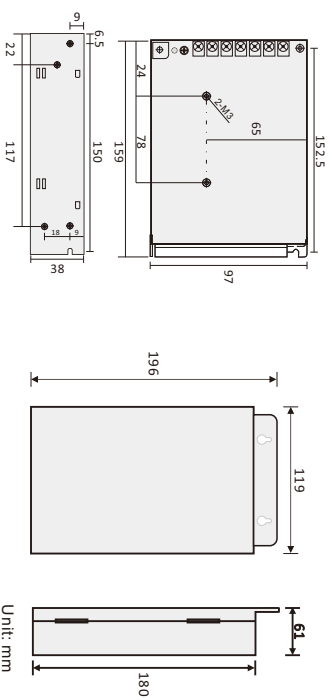

## 4. Specification

- Input Voltage:
- Input Frequency:
- Rated Output Voltage:
- Rated Output Current:
- Working Temperature:

100~120VAC(2.5A), 200~240VAC(1.5A)  
50~60 Hz  
24Vdc  
1.5A  
-20 C~+60 C

-2-

---

---

# USER MANUAL

---

2-wire Accessories  
Power Separator

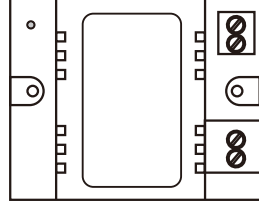

---

Please read this manual carefully before using the product.

---

---

# USER MANUAL

---

2-wire Accessories  
Power Separator

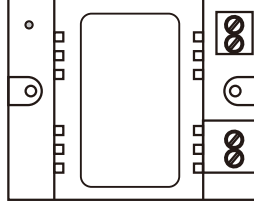

---

Please read this manual carefully before using the product.

## 1. Description

### 2-wire system power separator

- Power supply separator for connecting 1 door station
- Used with power supply
- 4 DIN modules

## 4. Specification

### • Power supply:

DC 24V

### • Working Temperature:

-10 D-+50 C °

### • Wiring:

2 wires (Non-polarity)

### • Dimension:

89(H) 870(W) 94,5(D)mm

## 2. Parts and Functions

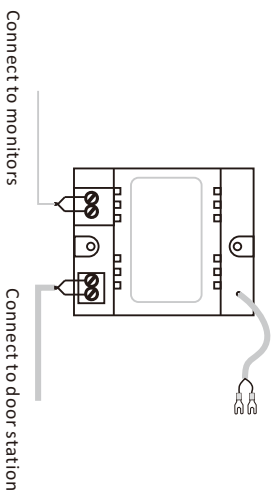

## 3. Installation

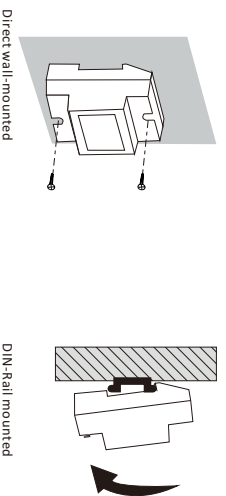

-1-

-2-

## 1. Description

### 2-wire system power separator

- Power supply separator for connecting 1 door station
- Used with power supply
- 4 DIN modules

## 4. Specification

### • Power supply:

DC 24V

### • Working Temperature:

-10 D-+50 C °

### • Wiring:

2 wires (Non-polarity)

### • Dimension:

89(H) 870(W) 94,5(D)mm

## 2. Parts and Functions

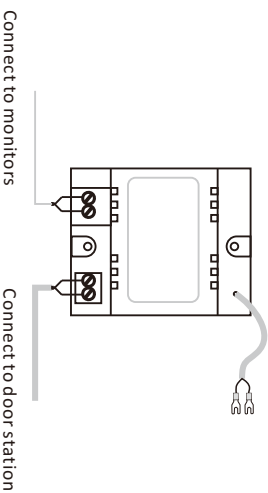

## 3. Installation

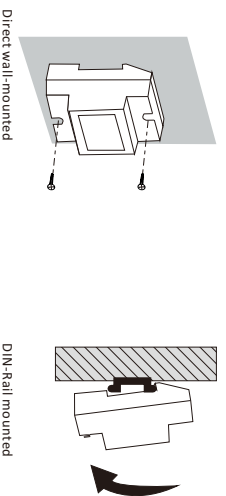

-1-

-2-



## Multi door station

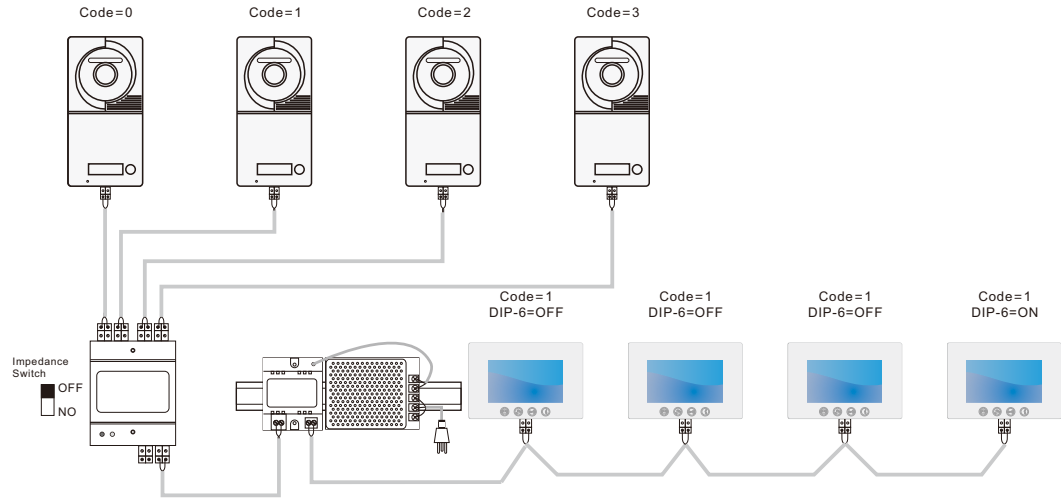

## Multi monitor wiring

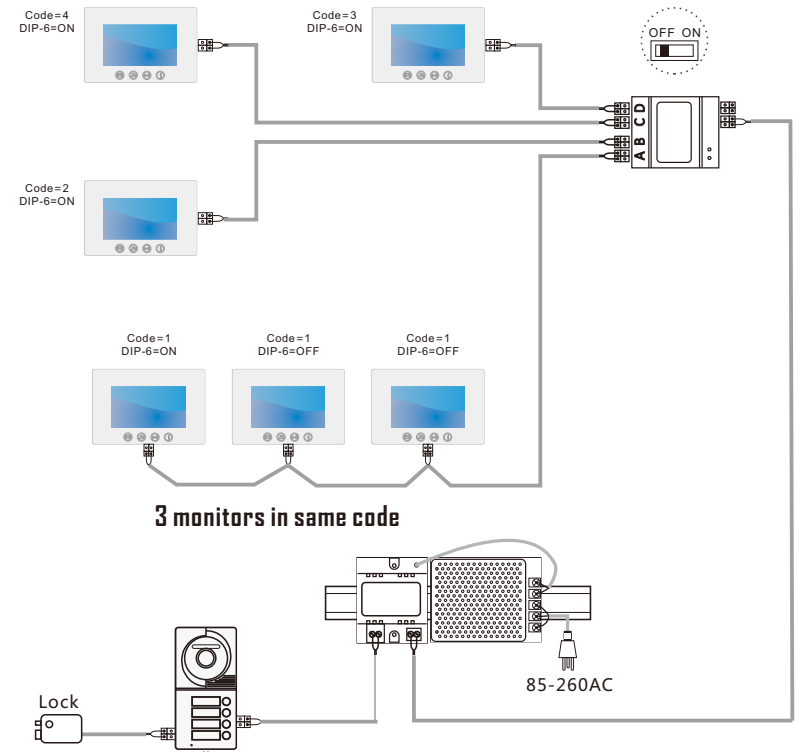

3 monitors in same code

## Multi monitor in same code

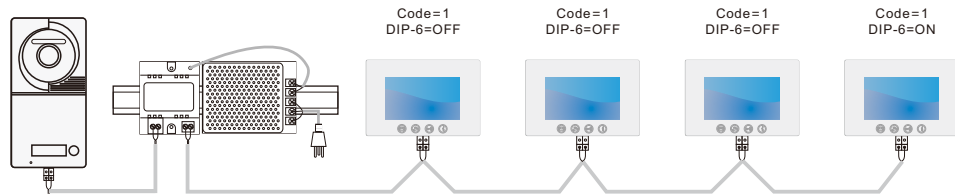

## Multi monitor in different code

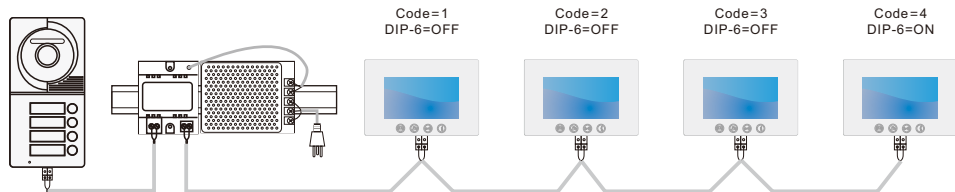

## Signal Amplifier Wiring diagram

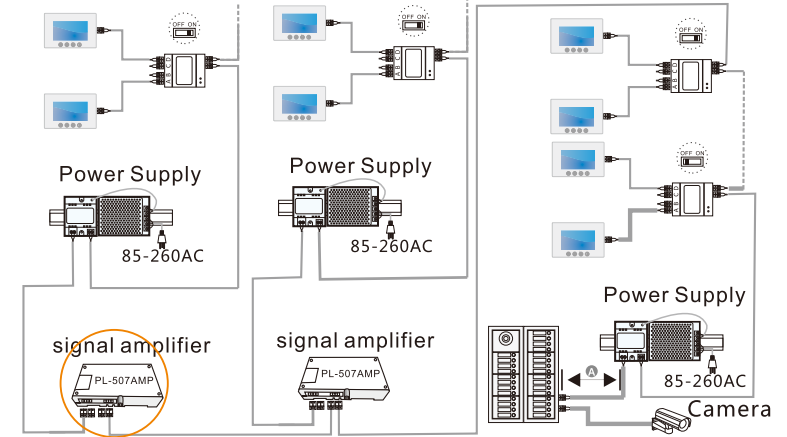

by connect with the signal amplifier can increase the distance between out door station and indoor station , what is more , by connect the signal amplifier can connect more indoor stations to the system.

P.S: 1-4 button door station don't use video distributor to connect with monitors. And also, larger power supply must be used when there is over 2 monitors in the same flat.